

Combined Energies

**Novel Power Electronics for Distributed Generation and
Energy Storage Applications**

**Hydrogen+Batteries+Fuel Cell Exhibit
Hannover Messe 2017**

Please visit us in booth C36/2 at the NEESC exhibit.



NYSERDA
Supported



Efficient by design

Company Overview

Combined Energies is a product development and manufacturing startup located in upstate New York.

Our vision for the residential micro-CHP market includes high-temperature PEM fuel cells, natural gas and propane reforming, absorption cooling and specialized power electronics.

Our first development to gain commercial traction is our DC-to-DC power converter, the Marathon LR, with its' high boost, bi-directional topology and detailed design described in U.S. Patent No. 9,413,271.

Leveraging investment from NYSERDA, NY STEP and the US Commercial Services we are exhibiting at the fair to showcase our technology, gather requirements and develop commercial partnerships.



Efficient by design

The Marathon LR

Motivation: There is a need for commercial power electronics that efficiently and cost-effectively convert variable, low-voltage DC power into steady, high-voltage DC for:

- Efficient conversion to AC with inverters
- Cost-effective DC power transfer
- Increased life of power generation and storage
- Attractive system architecture alternatives
- Increased useful energy production

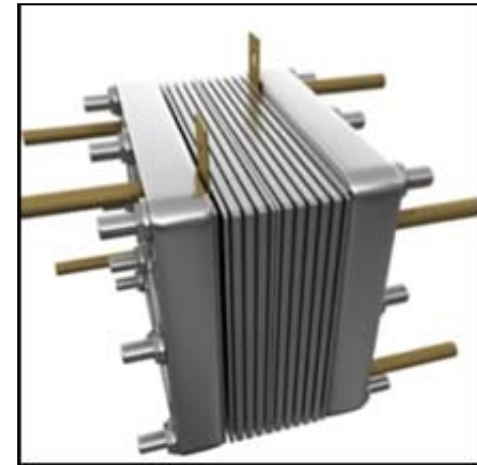

Technologies benefiting from high DC boost:

- - *CHP systems, PEM range extenders, flow batteries, energy storage, SOFC stacks, low-voltage battery strings, distributed generation, ultra-capacitors, regenerative braking, hydrogen generation, parasitic loads, portable power, tidal generation, energy scarfing, transportation - -*

The Marathon LR

Solution: Combine an existing, MOSFET-based, high-current friendly, DC-boost topology with a transformer stage to create a single power conversion device that provides:

- Greater than 10:1 DC power boost ratio
- High efficiency (>95%) at very low voltages
- Extended life of energy conversion and storage systems
- Operation with no active cooling requirements
- Variable degree of isolation
- Design latitude for low-voltage systems
- Increased opportunities for ultracapacitors
- Bi-directional or uni-directional operation

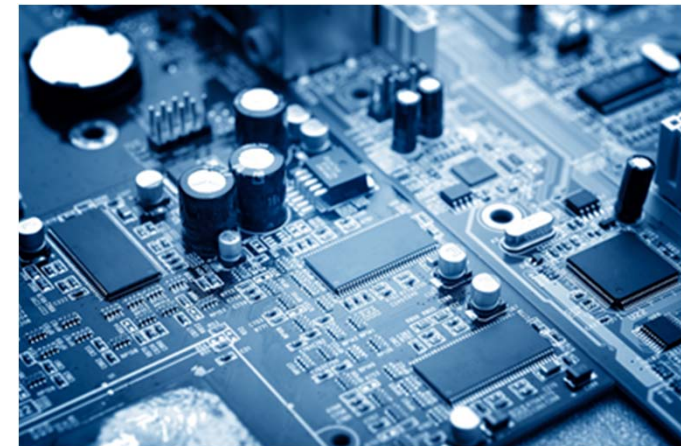

Technical Approach

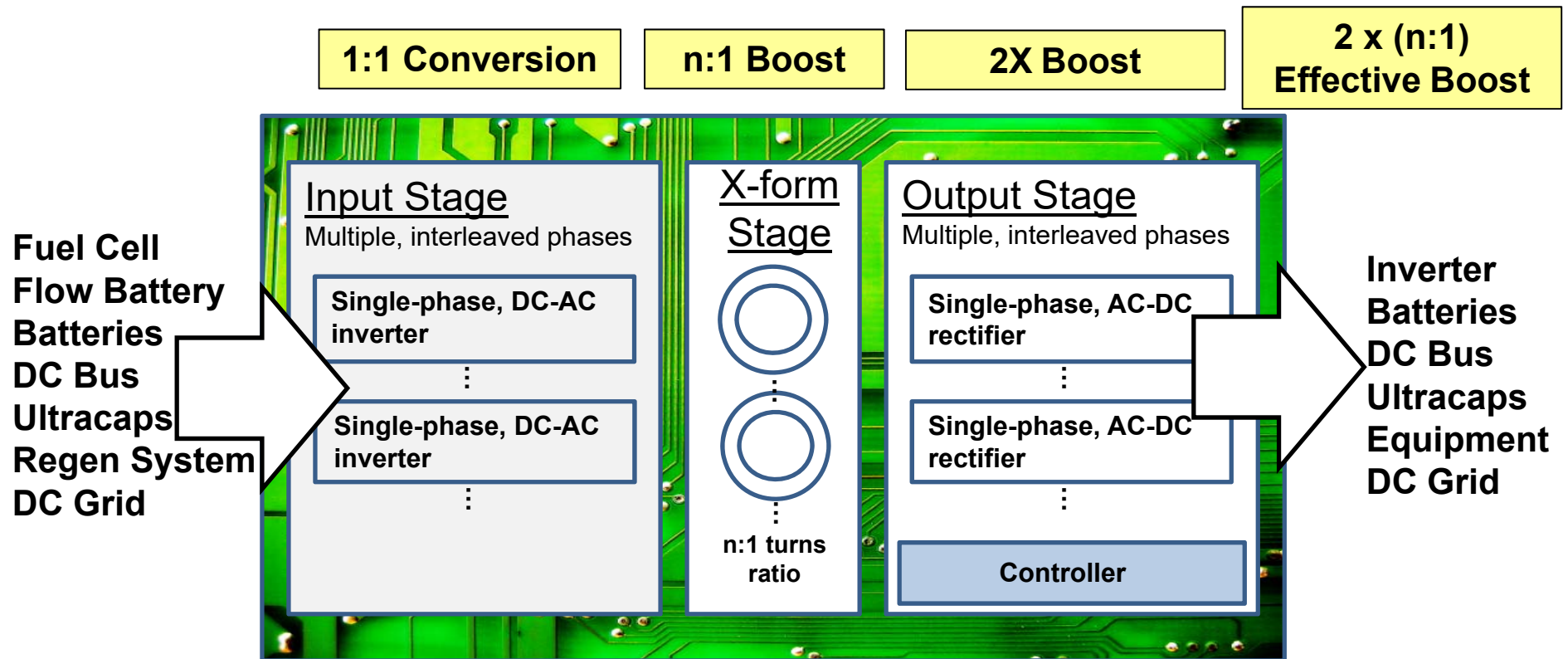

- Multiple phases used as building blocks
- Bi-directional capability
- Inner and outer loop control architecture

Application Example – Distributed Generation

Application in a Distributed Generation System

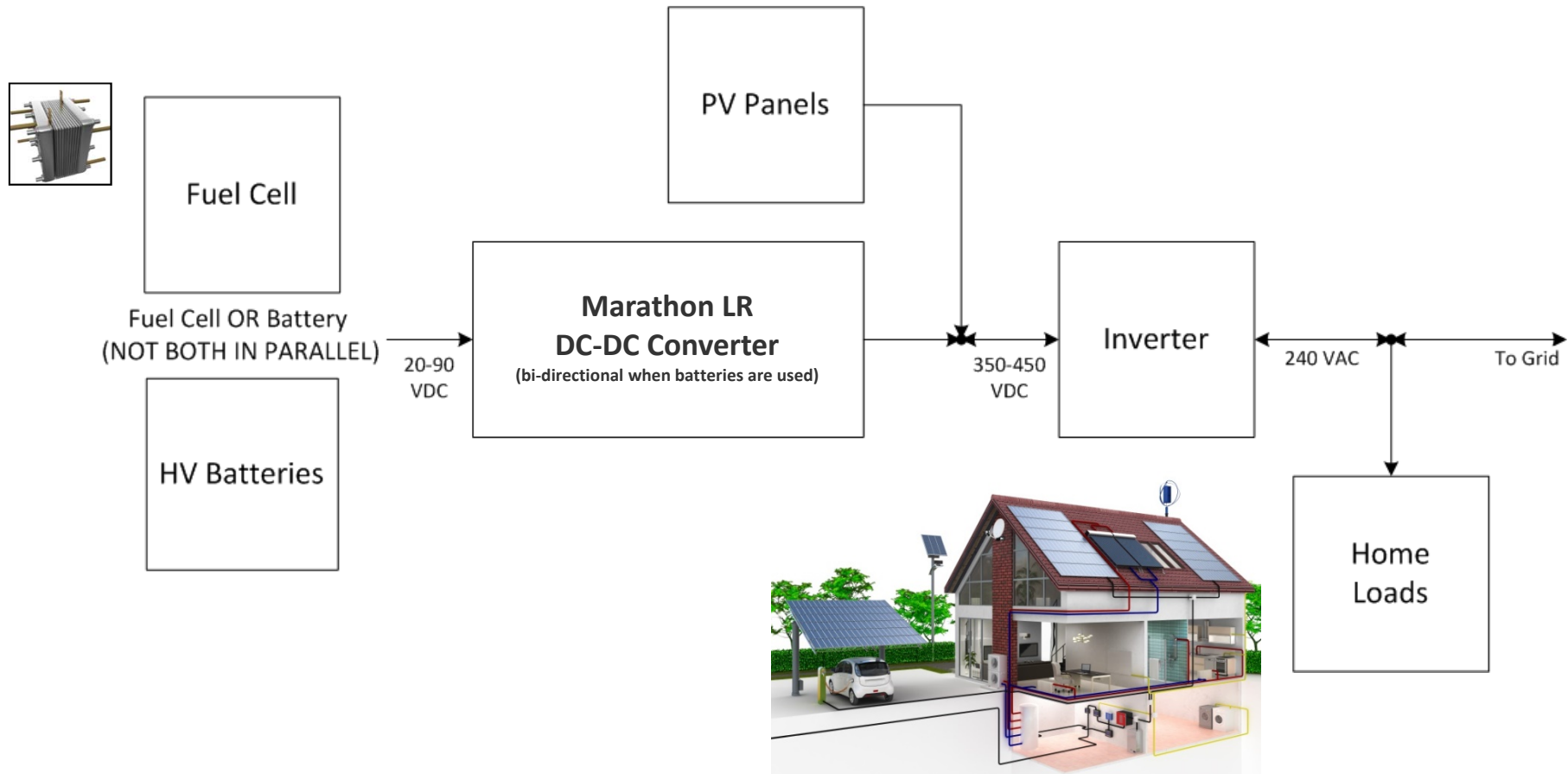

Application Example – Vehicle Range Extender

Application in a Hybrid/Electric Vehicle System

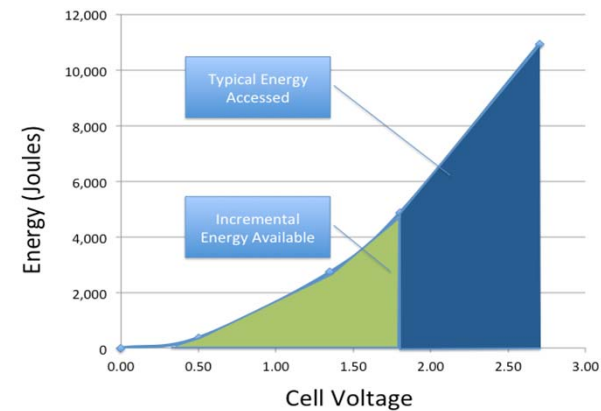
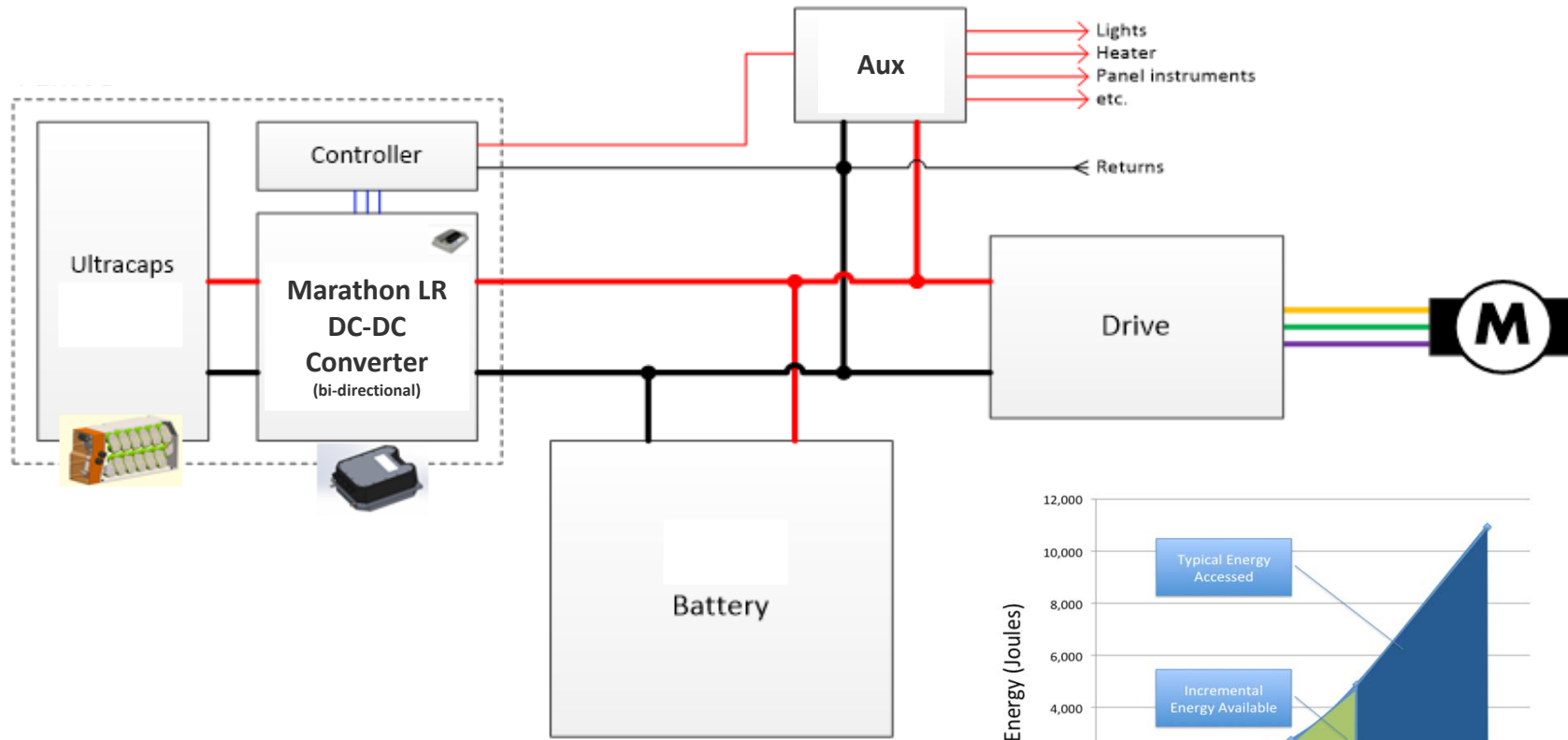

Application Example – Stack Optimizer

Application as a Stack Optimizer

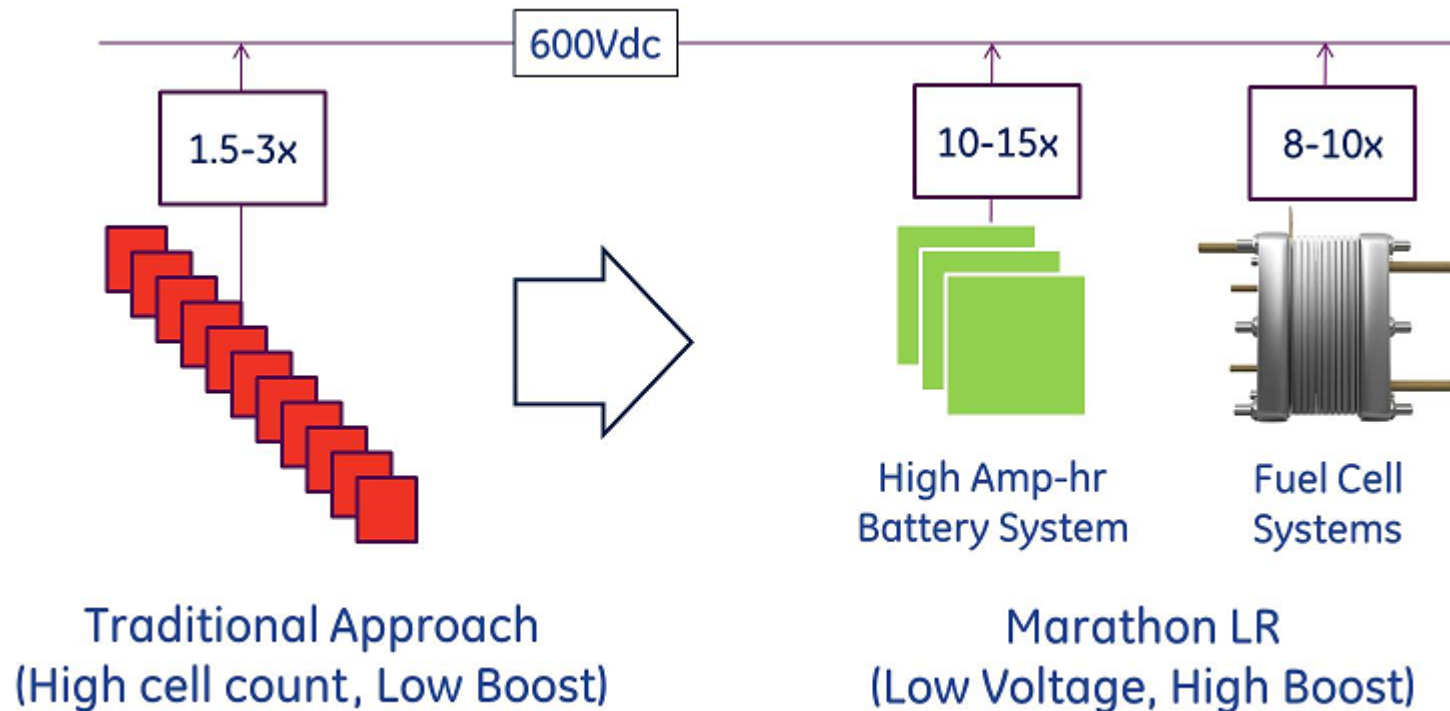

Commercial Status

Our prototypes are under test and evaluation in a variety of conditions.

Our initial, detailed design is embedded with a contract manufacturer in Rochester, NY USA.

We are gathering commercial requirements and looking for partners as we look to place our first samples in the field.

We believe the EU to be an important strategic market and that our presence here is critical to our long-term success.



Efficient by design

Thank you!

Combined Energies

Latham, NY USA

john.vogel@combined-energies.com



Efficient by design